



Instruction Manual

LeCroy CP031

Current Probe

Revision C – February, 2008



Warranty

LeCroy warrants this oscilloscope accessory for normal use and operation within specification for a period of one year from the date of shipment. Spare parts, replacement parts and repairs are warranted for 90 days.

In exercising its warranty, LeCroy, at its option, will either repair or replace any assembly returned within its warranty period to the Customer Service Department or an authorized service center. However, this will be done only if the product is determined by LeCroy's examination to be defective due to workmanship or materials, and the defect is not caused by misuse, neglect, accident, abnormal conditions of operation, or damage resulting from attempted repair or modifications by a non-authorized service facility.

The customer will be responsible for the transportation and insurance charges for the return of products to the service facility. LeCroy will return all products under warranty with transportation charges prepaid.

This warranty replaces all other warranties, expressed or implied, including but not limited to any implied warranty of merchantability, fitness or adequacy for any particular purposes or use. LeCroy shall not be liable for any special, incidental, or consequential damages, whether in contract or otherwise.

Corporate Headquarters

700 Chestnut Ridge Road
Chestnut Ridge, NY 10977-6499
Tel: (845) 578-6020, Fax: (845) 578-5985

Internet: www.lecroy.com

Copyright 2008 by LeCroy Corporation. All rights reserved.

LeCroy, ActiveDSO, JitterTrack, WavePro, WaveMaster, WaveSurfer, WaveLink, WaveExpert, WaveJet, and Waverunner are registered trademarks of LeCroy Corporation. Other product or brand names are trademarks or requested trademarks of their respective holders. Information in this publication supersedes all earlier versions. Specifications subject to change without notice.

CP031-OM-E Rev C **(Note:** This manual contains an updated Declaration of Conformity page. During this interim fix, the revision number shown here does not match the ones shown in the footers of this manual).

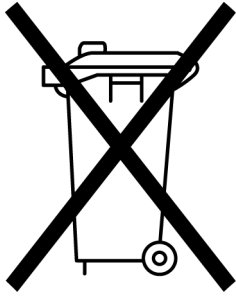
<p>Manufactured under an ISO 9000 Registered Quality Management System Visit www.lecroy.com to view the certificate.</p>	 <p>This electronic product is subject to disposal and recycling regulations that vary by country and region. Many countries prohibit the disposal of waste electronic equipment in standard waste receptacles. For more information about proper disposal and recycling of your LeCroy product, please visit www.lecroy.com/recycle.</p>
--	--





DECLARATION OF CONFORMITY

according to ISO/IEC Guide 22 and EN 45014:1998

Manufacturer's Name: LeCroy Corporation

Manufacturer's Address: 700 Chestnut Ridge Road
Chestnut Ridge, NY 10977
USA

herewith declare that

Product(s) Name: Current Probe

Model Number(s): CP030, CP031, CP150, CP500

including all their options are in conformity with the provisions of the following EC directive(s), including the latest amendments, and with national legislation implementing these directives:

73/23/EEC Low Voltage Directive

89/336/EEC EMC Directive

and that conformity with Council Directive 73/23/EEC is based on

EN 61010-2-032: 2002

Safety requirements for electrical equipment for measurement control and laboratory use

Part2-032: Particular requirements for hand-held and hand-manipulated current sensors for electrical test and measurement

and that conformity with Council Directive 89/336/EEC is based on

EN 61326/A3:2003

EMC requirements for electrical equipment for measurement control and laboratory use

Emissions	EN 55011/A2:2002	Conducted and Radiated Emissions
Immunity	EN 61000-4-2/A2:2001	Electrostatic Discharge
	EN 61000-4-3/A1:2003	RF Radiated Electromagnetic Field
	EN 61000-4-4:2004	Electrical Fast Transient/Burst
	EN 61000-4-5/A1:2001	Surge
	EN 61000-4-6/A1:2001	RF Conducted Electromagnetic Field

By: David C. Graef
Vice President & Chief Technology Officer

Place: LeCroy Corporation
700 Chestnut Ridge Road
Chestnut Ridge, NY 10977
USA

Date: December 18, 2007

European Contact:
Your local LeCroy Sales Office or

LeCroy Europe GmbH
Waldhofer Str 104
D-69123 Heidelberg
Germany

Tel: (49) 6221 82700
Fax: (49) 6221 834655

Warning: This is a Class A product. In a domestic environment this product may cause radio interference, in which case the user may be required to take adequate measures.

BLANK PAGE

Table of Contents



Safety Information	1-1
Operator Safety	1-1
Operating Environment	1-1
Safety Symbols	1-1
Usage	1-2
Overview	2-1
Description	2-1
Key features	2-1
Conventions used in this Manual	2-1
Accessories	2-2
Operation	3-1
Precautions	3-1
Connecting the Probe to the Test Instrument	3-1
Connecting the Probe to the test Circuit	3-1
Operation with a LeCroy Oscilloscope	3-2
AC Coupling	3-2
Bandwidth Limit	3-2
Auto Zero	3-2
Degauss Probe	3-3
Care and Maintenance	4-1
Cleaning	4-1
Calibration Interval	4-1
Service Strategy	4-1
Troubleshooting	4-1
Returning a Defective Probe	4-2
Returning a Probe to a Different Country	4-3
Performance Verification	5-1
Test Equipment Required	5-1
Preliminary Procedure	5-2
Functional Check	5-2
Performance Verification Procedure	5-2
Check DC Accuracy	5-3
Adjustment Procedure	6-1
Test Equipment Required	6-1

CP031 Current Probe

Adjustment Procedure	6-2
Preliminary Procedure	6-2
Adjust DC Accuracy.	6-2



Specifications	7-1
Nominal Characteristics	7-1
Warranted Characteristics	7-1
Typical characteristics	7-1
Environmental Characteristics	7-2
Physical Characteristics	7-2
Compliances and Certifications	7-3
Graphs	7-4

Appendix A	A-1
Performance Verification Test Record	A-1
Equipment Used:	A-1

Safety Information

OPERATOR SAFETY

To avoid personal injury and to prevent damage to the probe or any products connected to it, review the following safety precautions.





OPERATING ENVIRONMENT

Before using this probe, ensure that its operating environment will be maintained within these parameters:

Temperature	0 to 40 °C (32 to 104 °F)
Humidity	≤ 80% RH (non-condensing)
Altitude	Up to 2000 m (6562 ft)
Operation	In-door Use

SAFETY SYMBOLS

Whenever the following safety symbols appear in the instruction manual or on the probe, they alert the user to an aspect of safety.

Symbol	Meaning
	Refer to accompanying documents (for safety related information)
CAUTION	Calls attention to a procedure, practice or condition that could possibly cause damage to equipment
WARNING	Calls attention to a procedure, practice or condition that could possibly cause bodily injury or death
	Risk of electrical shock
	Earth ground
	Probe is protected by reinforced or double insulation

CP031 Current Probe

USAGE

The probe is intended to be used only with instruments that are connected to earth ground through the input connector. The probe is not intended to be used in wet or explosive atmospheres.



The use of the probe and/or the instrument it is connected to in a manner other than that specified may impair the safety mechanisms.



In order to assure safe operation and to obtain maximum performance from the unit, observe the following:

1. To avoid short circuits and accidents that could result in injury or death, use the CP031 current probe only with conductors carrying 300 V or less.
2. In order to prevent short circuits and electric shock when conductors being measured carry less than 300 V but more than the safe voltage level (SELV-E) make sure that the conductors to be measured are insulated with material conforming to:
 - Overvoltage Category I
Basic insulation requirement for working voltage of 300 V.
 - Pollution degree 2
3. Never install or remove the probe on bare conductors which are energized. The transformer core and shield are grounded but not insulated and may contact the conductor when the locking lever is open.
4. Be careful not to damage the insulation surface when making measurements.
5. Do not use the probe if any part is damaged. All maintenance should be referred to qualified service personnel.

Safety Information

To guarantee accurate performance characteristics, mechanical shock should be avoided, as well as damage to the cable through excessive bending. The probe case is not sealed and should never be immersed in any fluid. Do not exceed the maximum specified current/voltage levels. (See Specifications).



###

CP031 Current Probe

BLANK PAGE

Overview

DESCRIPTION

The CP031 uses a combination of Hall effect and transformer technology which enables measurements to be made on DC, AC and impulse currents. It has a 100 MHz bandwidth and is designed to measure continuous currents up to 30 Amp.

The probe can be used with a WaveSurfer, WaveRunner 6000, or WavePro 7000 series oscilloscope with firmware 4.3.0.0 or higher. With the ProBus interface, the CP031 becomes an integral part of the oscilloscope. The bandwidth limit, auto zero and degauss functions are all controlled from the oscilloscope's front panel. The oscilloscope provides power to the probe, so no external power supply is needed.

KEY FEATURES

- Highly accurate current measurements
- Easy current measurements
- Wide bandwidth
- Compact
- Over-current protected

CONVENTIONS USED IN THIS MANUAL

The following conventions may appear in this manual:

Note

A Note contains information relating to the use of the product.

CAUTION

A Caution contains information that should be followed to avoid possible damage to the instrument or the device under test.

WARNING

A Warning alerts you to a potential hazard. Failure to adhere to the statement in a WARNING message could result in personal injury.

CP031 Current Probe

The following symbols may appear on the product:



CAUTION: Refer to accompanying documents

This refers you to additional information contained in this manual. The corresponding information in the manual is similarly denoted.



CAUTION: Risk of electric shock

This is a reminder that high voltage may be present and that appropriate caution should be taken.



This is the symbol for earth ground.

ACCESSORIES

Certificate of Calibration

Instruction Manual.

CP031-OM-E

###

Operation

PRECAUTIONS

Note

The sensor head is a precision assembly consisting of a molded component with a ferrite core and a Hall effect element. It may be damaged if subjected to sudden changes in temperature, mechanical strain or shock.

The mating surfaces of the sensor are precision ground and should be treated with care. If there is any type of dust or dirt on the mating surfaces of the sensor head, measurements may be impaired.

Note

Accurate measurements may not be possible in locations subject to strong magnetic fields such as transformers and high-current conductors, or in locations subject to strong external electric fields.

CONNECTING THE PROBE TO THE TEST INSTRUMENT

The CP031 probe has been designed for use with the WaveSurfer, WaveRunner 6000, WavePro 7000, and WaveMaster series LeCroy oscilloscopes equipped with the ProBus interface. Attach the probe output connector to the oscilloscope input connector. The oscilloscope will recognize the probe, set the oscilloscope input termination to 1 M Ω and activate the probe control functions in the user interface. To use the CP031 with a WaveMaster scope, the AP-1M impedance adapter is required.

CONNECTING THE PROBE TO THE TEST CIRCUIT

The CP031 has been designed with a movable split core, eliminating the need to break the conductor for the core to slip around the conductor.

To connect:

1. Pull the slider, so that the clamp opens.
2. Align the sensor so that the current direction indicator corresponds to the direction of current flow in the conductor.

CP031 Current Probe

3. Close the slider on the sensor head until the "UNLOCK" indication disappears and the "LOCK" indication appears.
4. Verify that the opening lever is firmly locked and the clamp is securely closed.

Note

Never use this probe on bare conductors. The core and shield are grounded and any voltage applied to the conductor may cause damage to the probe or the circuit under test.

OPERATION WITH A LECROY OSCILLOSCOPE

Control through the oscilloscope user interface can be found in the channel dialog to which the probe is connected.

Turning the **VOLTS/DIV** knob will control the oscilloscope's scale factor to give full dynamic range from 20 mA/div to 50 A/div.

Figure 3-1 shows the oscilloscope user interface menu for the CP031 probe. The menu allows for the selection of the probe's coupling (**DC**, **Grounded** or **AC**), **AUTO ZERO**, **DEGAUSS PROBE** and **Probe BWL** functions, limiting the system bandwidth to 20 MHz or maximum bandwidth (BWL Off).

BANDWIDTH LIMIT

The CP031 is capable of switching the bandwidth from **Full** (maximum bandwidth) to **20 MHz** by selecting the bandwidth adjustment in the channel menu.

AUTO ZERO

The CP031 incorporates an Auto Zero function to remove the DC offset from the current probe. Auto Zero must be invoked by the user. After several minutes of warm-up, or when the probe is exposed to a large shift in ambient temperature, some DC offset drift may occur. To initiate an Auto Zero cycle press touch the CP031 tab, then the **AUTO ZERO** button.

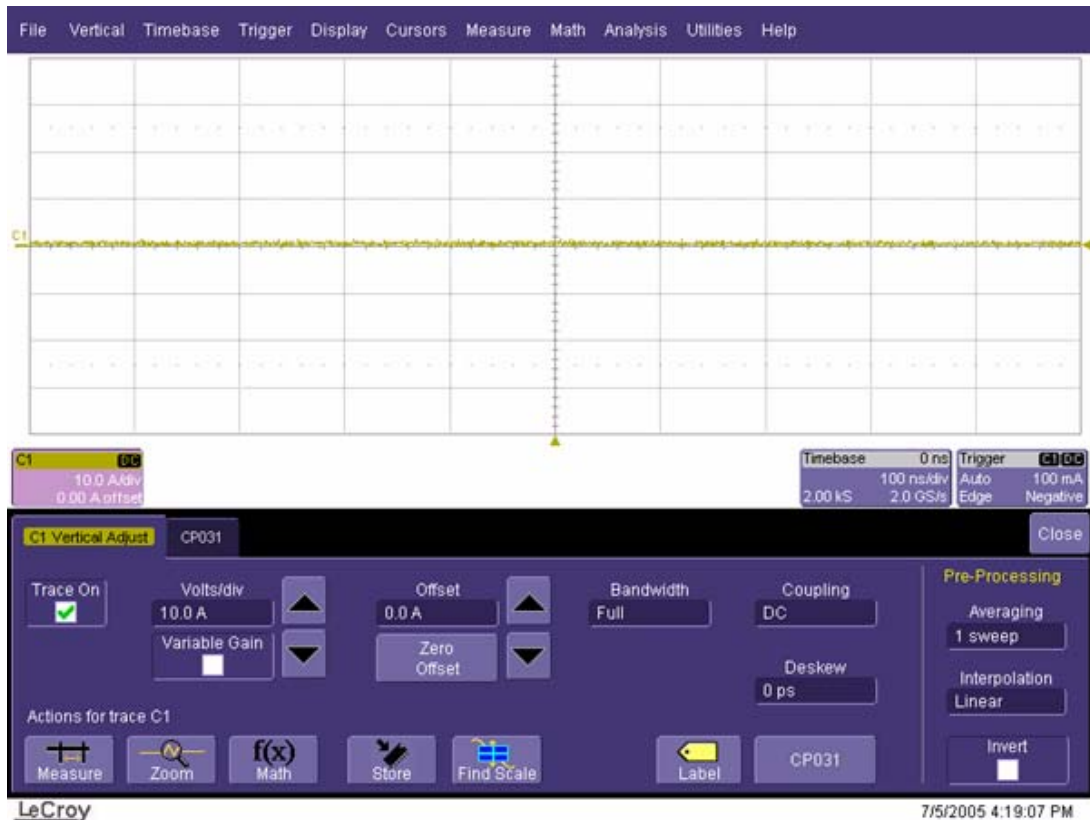

Figure 3-1. Oscilloscope display with menu

DEGAUSS PROBE

If the probe has been magnetized by external magnetic field or by excessive input, the core can be demagnetized by touching the CP031 tab, then the **DeGauss Probe** button.

The demagnetizing process takes about 5 seconds and should always be performed before taking a measurement.

Without clamping the probe around a conductor, slide the opening lever to close and lock the probe and press the **DEGAUSS PROBE** button.

An Auto Zero is automatically performed as part of the degauss cycle.

###

CP031 Current Probe

BLANK PAGE

Care and Maintenance

CLEANING

The exterior of the probe and cable should be cleaned only using a soft cloth moistened with water or isopropyl alcohol. The use of abrasive agent, strong detergents or other solvents may damage the probe.



CAUTION

The probe case is not sealed and should never be immersed in any fluid.

CALIBRATION INTERVAL

The recommended calibration interval is one year. Adjustment should only be performed by qualified personnel. (A Performance Verification / Adjustment procedure is included in this manual.)

SERVICE STRATEGY

Defective probes must be returned to a LeCroy service facility for diagnosis and exchange. A defective probe under warranty will be replaced with a factory refurbished probe. A probe that is not under warranty can be exchanged for a factory refurbished probe. A modest fee is charged for this service. A defective probe must be returned in order to receive credit for the probe core.

TROUBLESHOOTING

If the probe is not operating properly the problem may be the way in which it is used. Before assuming the probe is defective, perform the following troubleshooting procedures:

1. Verify using on the LeCroy oscilloscope running firmware 4.3.0.0 or higher. (The firmware version of your oscilloscope can be verified by selecting **Utilities**, **Utilities Setup**, then the **Status** tab.)
2. Waveform is inverted — Make sure the arrow on the slider is in the direction of the current flow.
3. No signal — Make sure the slider is closed and locked.

CP031 Current Probe

RETURNING A DEFECTIVE PROBE

The procedure for returning a defective probe is as follows:

Contact your local LeCroy sales representative to find out where to return the product. All returned products should be identified by model number and serial number. Provide your name and contact number and if possible describe the defect or failure. In case of products returned to the factory, a Return Authorization Number (RAN) should be used. The RAN can be established by contacting your nearest LeCroy office, or the New York Customer Care Center.

Return shipment should be prepaid. LeCroy cannot accept COD or Collect Return shipments. We recommend air-freighting.

Note

It is important that the RAN be clearly shown on the outside of the shipping package for prompt redirection to the appropriate department.

1. Contact your local LeCroy sales or service representative to obtain a Return Authorization Number.
2. Remove all accessories from the probe. Do not include the manual.
3. Pack the probe in its case, surrounded by the original packing material (or equivalent) and box.
4. Label the case with a tag containing:
 - The RAN
 - Name and address of the owner
 - Probe model and serial number
 - Description of failure
5. Package the probe case in a cardboard shipping box with adequate padding to avoid damage in transit.
6. Mark the outside of the box with the shipping address given to you by the LeCroy representative; be sure to add the following:
 - ATTN: <RAN assigned by the LeCroy representative>
 - FRAGILE

Care and Maintenance

7. Insure the item for the replacement cost of the probe.
8. Ship the package to the appropriate address.

RETURNING A PROBE TO A DIFFERENT COUNTRY

In order to avoid customs duty for purchase price of a new probe or accessory, when your probe is returned for service, please use the following procedure.

In addition to the items mentioned above in 'Returning a defective probe', you'll need to mark shipments returned for service as a 'Return of US manufactured goods for warranty repair/recalibration'. If there is a cost involved in the service, put the cost of the service in the value column and the original value of the product at time of purchase in the body of the invoice marked 'For insurance purposes only'. Be very specific as to the reason for shipment.

Duties may have to be paid on the value of the service.

####

CP031 Current Probe

BLANK PAGE

Performance Verification

This procedure can be used to verify the warranted characteristics of the CP031 Current Probe.

The recommended calibration interval for the model CP031 Current Probe is one year. The complete performance verification procedure should be performed as the first step of annual calibration. Test results can be recorded on a photocopy of the Test Record provided at the end of the manual.

Performance verification can be completed without removing the probe covers or exposing the user to hazardous voltages. Adjustment should only be attempted if a parameter measured in the Performance Verification Procedure is outside the specification limits.

Adjustment should only be performed by qualified personnel.

TEST EQUIPMENT REQUIRED

The following table lists the test equipment and accessories (or their equivalents) which are required for performance verification of the CP031 Current Probe.

Because the input and output connector types may vary on different brands and models of test instruments, additional adapters or cables may be required.

Table 5-1. List of Required Equipment

Description	Minimum Requirements	Test Equipment Examples
Wide Band Oscilloscope	Minimum 200 MHz bandwidth ProBus interface equipped Software version 4.3.0.0 or higher	LeCroy WaveRunner 6030A
Digital Multimeter (2 required)	DC: 0.1% Accuracy 5½ digit resolution	Agilent Technologies 34401A or Fluke 8842A-09
Function Generator	50 Hz sine wave output. 3 Vrms into 50Ω	Agilent Technologies 33120A or Stanford Research Model DS340
Calibration Fixture, 100 Turn Loop	100 Turn loop in series with 0.5Ω ± 0.1% resistor with sense terminals.	LeCroy CP031-CF02
Calibration Fixture	ProBus Extension Cable	LeCroy PROBUS-CF01

CP031 Current Probe

Description	Minimum Requirements	Test Equipment Examples
Banana Plug Adapter	Female BNC to Dual Banana Plug	Pomona 1269
Patch Cables (4 required)	Male Banana to Male Banana, 12"	Pomona B-12-0 (black), B-12-2 (red)
BNC Adapter	BNC Male to Dual Banana Jack	Pomona 1296

PRELIMINARY PROCEDURE

1. Connect the CP031 to the channel 1 input of the oscilloscope and completely close the probe slider.
2. Turn the oscilloscope on and allow at least 30 minutes warm-up time for the CP031 and test equipment before performing the Verification Procedure.
3. Turn on the other test equipment and allow these to warm up for the time recommended by the manufacturer.
4. While the instruments are reaching operating temperature, make a photocopy of the Performance Verification Test Record (located in Appendix A), and fill in the necessary data.

FUNCTIONAL CHECK

The functional check will verify the basic operation of the probe functions.

It is recommended that the Functional Check be performed prior to the Performance Verification Procedure.

1. Select Channel 1 and verify that the probe bandwidth is set to **Full**.
2. Verify that the CP031 is sensed and the **CP031** tab appears in the channel menu.
3. Degauss the probe by pressing the **DEGAUSS** button and selecting **OK** (located on the CP031 dialog).
4. Verify that "Performing Degauss on CP031...." is displayed at the bottom of the screen and no error message remains displayed.

Performance Verification

PERFORMANCE VERIFICATION PROCEDURE

The warranted characteristics of the CP031 Current Probe are valid at any temperature within the Environmental Characteristics listed in the Specifications. However, some of the other test equipment used to verify the performance may have environmental limitations required to meet the accuracy needed for the procedure. Make sure that the ambient conditions meet the requirements of all the test instruments used in his procedure.

Note

The correct operation of the CP031 controls requires software version 4.3.0.0 or higher. The software version in the test oscilloscope can be verified by selecting **Utilities, Utilities Setup**, then the **Status** tab. Contact your local LeCroy representative if the software in your oscilloscope requires updating.

CHECK LF ACCURACY

1. Set the Function generator to 50 Hz sine wave. Output voltage at $3 V_{rms}$ with 50Ω output.

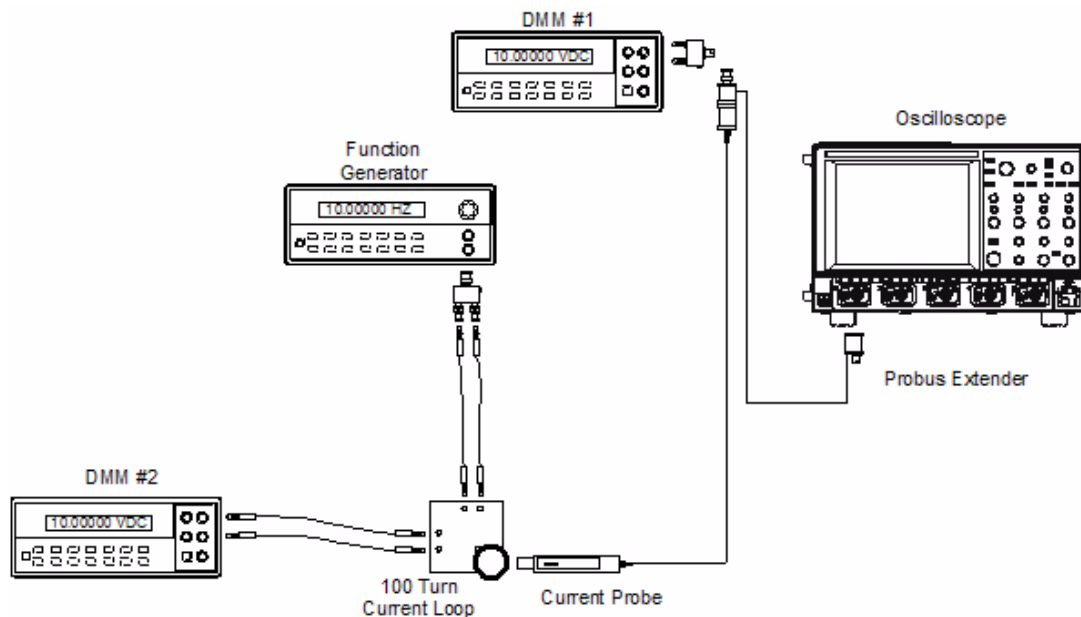

Figure 5-1. LF Accuracy Test Set Up

CP031 Current Probe

2. Remove the CP031 from the oscilloscope and reconnect using the ProBus extension cable. Connect the BNC male connector of the ProBus extension to DMM #1 using a BNC Female to Dual Banana adapter.
3. Using Banana Patch cords and the BNC to Dual Banana Plug adapter, connect the 'V Source' and 'V Return' terminals of the 100 Turn Calibration Loop to the output of the Function Generator.
4. Connect the Current Sense terminals of the 100 Turn Calibration Loop to the voltage inputs of DMM #2.
5. Set both DMMs to measure AC Volt.
6. With the CP031 removed from any signal and the slider returned to the LOCKED position, degauss the probe by pressing the **DEGAUSS** button (located in the CP031 dialog), then press **OK**.
7. Open the CP031 slider and position the probe input around the 100 Turn loop. Close and LOCK the slider.
8. Adjust the Function generator voltage until the voltage measured at the 'Current Sense' terminals (DMM #2) reads 50 mV \pm 0.05 mV. (This corresponds to 10 A at the probe head).
9. Record the voltage measured by DMM #1 on the Test Record.
10. Verify that the measured voltage is between 0.989 volt and 1.011 volt.

###

Adjustment Procedure

This procedure can be used to adjust the warranted characteristics of the CP031 Current Probe. This procedure should be used if a parameter measured in the Performance Verification Procedure is outside of the specification limits.

Adjustment should only be performed by qualified personnel.

TEST EQUIPMENT REQUIRED

The following table lists the test equipment and accessories, or their equivalents, which are required for adjustment of the CP031 Current Probe.

Because the input and output connector types may vary on different brands and models of test instruments, additional adapters or cables may be required.

Table 6-1. List of Required Equipment

Description	Minimum Requirements	Test Equipment Examples
Wide Band Oscilloscope	Minimum 200 MHz bandwidth ProBus interface equipped Software version 4.3.0.0 or higher	LeCroy WaveRunner 6030A
Digital Multimeter (2 required)	DC: 0.1% Accuracy 5½ digit resolution	Agilent Technologies 34401A, or Fluke 8842A-09
Function Generator	50 Hz sine wave output. 3 Vrms into 50 Ω	Agilent Technologies 33120A, or Stanford Research Model DS340
Calibration Fixture, 100 Turn Loop	100 Turn loop in series with 0.5 Ω ±0.1% resistor with sense terminals.	LeCroy CP031-CF02
Calibration Fixture	ProBus Extension Cable	LeCroy PROBUS-CF01
Banana Plug Adapter	Female BNC to Dual Banana Plug	Pomona 1269
Patch Cables (4 required)	Male Banana to Male Banana, 12"	Pomona B-12-0 (black), B-12-2 (red)
BNC Adapter	BNC Male to Dual Banana Jack	Pomona 1296

CP031 Current Probe

ADJUSTMENT PROCEDURE

The warranted characteristics of the CP031 Current Probe are valid at any temperature within the Environmental Characteristics listed in the Specifications. However, some of the other test equipment used to verify the performance may have environmental limitations required to meet the accuracy needed for the procedure. Make sure that the ambient conditions meet the requirements of all the test instruments used in this procedure.

Note:

*The correct operation of the controls of the CP031 requires oscilloscope software version 4.3.0.0 or higher. The software version in the test oscilloscope can be verified by selecting **Utilities, Utilities Setup**, then the **Status** tab. Contact your local LeCroy representative if the software in your oscilloscope requires updating.*

PRELIMINARY PROCEDURE

1. Remove the probe compensation box circuit board by removing the two screws from the cable end of the compensation box and sliding the circuit board out of the box.
2. Connect the CP031 compensation board to the channel 1 input of the oscilloscope through the ProBUS extension cable, and completely close the probe slider.
3. Turn the oscilloscope on and allow at least 30 minutes warm-up time for the CP031 and test equipment before performing the Verification Procedure.

ADJUST LF ACCURACY.

1. Set the Function Generator to 50 Hz, sinewave output at 3 Vrms with 50 Ω output.
2. Connect BNC male of ProBus extension to DMM #1 using BNC Female to Dual Banana adapter.
3. Using banana patch cords, connect the 'V Source' and 'V Return' terminals of the 100 Turn Calibration Loop, to the output of the Function Generator using the BNC to Dual Banana Plug Adapter output. (Refer to Figure 6-1)

Adjustment Procedure

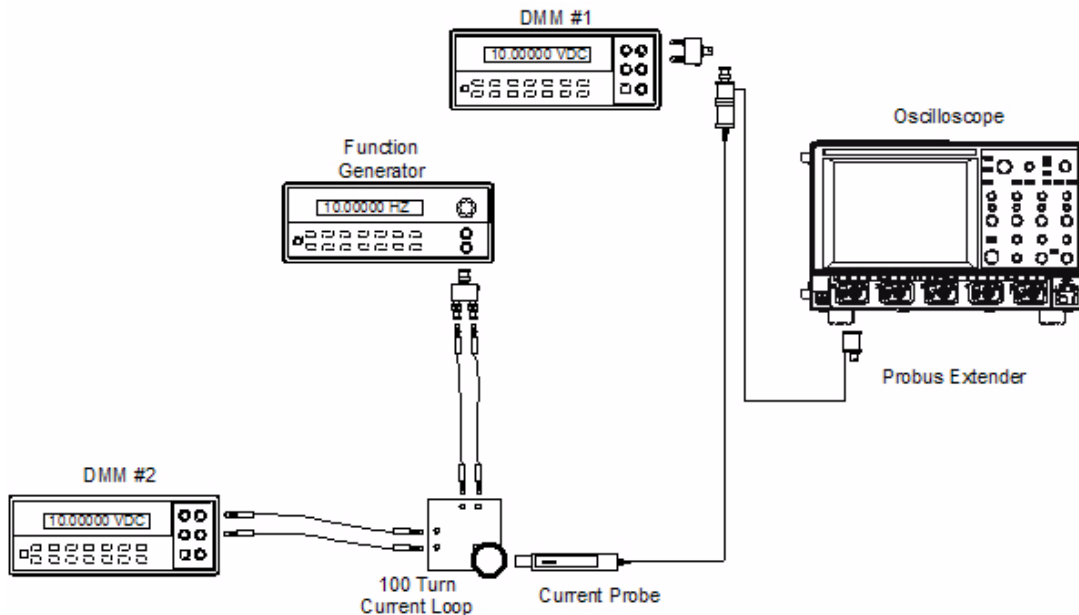

Figure 6-1. LF Accuracy Adjustment Set Up

4. Connect the Current Sense terminals of the 100 Turn Calibration Loop to the voltage inputs of DMM #2
5. Set both DMMs to measure AC Volt.
6. With the CP031 removed from any signal and the slider returned to the LOCKED position, degauss the probe by pressing the **DEGAUSS** button on the oscilloscope, (located in the CP031 dialog), then pressing OK.
7. Open the CP031 slider and position the probe input around the 100 Turn loop. Close and LOCK the slider.
8. Adjust the Function Generator voltage until the voltage measured at the 'Current Sense' terminals (DMM #2) is $50 \text{ mV} \pm 0.05 \text{ mV}$. (This corresponds to 10 A at the probe head).
9. Adjust VR202 on the PCB until the voltage measured on DMM #1 is as close to 2X the voltage measured on DMM #2.
10. Verify that the measured voltage is between 0.990 V and 1.01 V.
11. Disconnect the probe from the test setup.

CP031 Current Probe

12. Re-assemble the compensation box by sliding the circuit board back into the box and inserting and fastening the two screws.

###

Specifications

NOMINAL CHARACTERISTICS

Nominal characteristics describe parameters and attributes which are guaranteed by design, but do not have associated tolerances.

Maximum Continuous Input Current	30 Amp rms Refer to figure 7-1, Maximum Input Current vs. Frequency.
Maximum Peak Current	50 Amp peak, noncontinuous
Insertion Impedance	Refer to figure 7-2, Insertion Impedance vs. Frequency
Intended Output Load	1 M Ω
Maximum Permitted Circuit Voltage	300 V, CAT I (Insulated conductor).



WARRANTED CHARACTERISTICS

Warranted characteristics describe parameters which have guaranteed performance. Unless otherwise noted, tests are provided in the Performance Verification Procedure for all warranted specifications.

Guaranteed at 23 °C \pm 5 °C (73 °F \pm 9 °F) after power has been applied for 30 minutes.

Amplitude Accuracy	\pm 1.0% of reading \pm 10 mA; to 30 A _{rms} \pm 2.0% of reading; to 50 A _{peak} (DC, 45 to 65 Hz)
--------------------	--

TYPICAL CHARACTERISTICS

Typical characteristics describe parameters which do not have guaranteed performance, however are representative of the average performance from a sample of several probes. Tests for typical characteristics are not provided in the Performance Verification procedure.

Sensitivity*	20 mA/div* to 50 A/div.
--------------	-------------------------

CP031 Current Probe

Output voltage	0.1 V/A
----------------	---------

* Lower sensitivity may change with different oscilloscope models.

Sensitivity Temperature Coefficient	±2% or less. (from 0° to +40 °C, 32 °F to 104 °F).
Noise	Equivalent to 2.5 mA rms or less (Bandwidth of measuring instrument: 20 MHz).
Bandwidth	DC to 100 MHz. Rise Time ≤ 3.5 ns.

ENVIRONMENTAL CHARACTERISTICS

Operating Temperature Humidity	0 to 40 °C (32 °F to 104 °F) ≤ 80% relative humidity (non-condensing)
Storage Temperature Humidity	−10 °C to 50 °C (14 °F to 122 °F) ≤80% relative humidity (non-condensing)
Usage	Indoor
Altitude	up to 2000 m (6562 feet)
Effect of External Magnetic Field	Equivalent to a maximum of 5 mA (in a DC or 60 Hz, 400 A/m magnetic field).

PHYSICAL CHARACTERISTICS

Dimensions Probe	
Length	175 mm (6.9 inch)
Width	18 mm (0.7 inch)
Height	40 mm (1.57 inch)
Dimensions Compensation Box	
Length	65 mm (2.6 inch)
Width	39 mm (1.5 inch)
Height	24 mm (0.9 inch)
Weight	240 g (8.5 oz.)
Maximum diameter of conductors to be measured	5 mm (0.2 inch)

COMPLIANCES AND CERTIFICATIONS

<p>EC Declaration of Conformity</p>	<p>Meets intent of the European Council Directives 73/23/EEC for product safety and 89/336/EEC for electromagnetic compatibility. This declaratrion is based upon compliance of the CP031 to the following standards:</p> <p>EN 61326:1997 +A1:1998 +A2:2001 +A3:2003 EMC requirements for electrical equipment for measurement, control, and laboratory use.</p> <p>Emissions:</p> <p>EN 55022:1994 +A1:1995 +A2:1997 Radiated & Conducted Emissions Class B</p> <p>Immunity:</p> <p>EN 61000-4-2:1999 Electrostatic discharge (±4 kV contact discharge; ±8 kV air discharge)</p> <p>EN 61000-4-3:2002 +A1:2003 RF Radiated Fields (3 V/m, 80 MHz to 1 GHz, 80% amplitude modulated)</p> <p>EN 61000-4-5: 1995+A1:2001 Surge (1 kV differential mode, 2 kV common mode)</p> <p>EN 61000-4-6: 1996+A1:2001 RF Conducted Field (3 V, 150 kHz to 80 MHz, amplitude modulated with 1 kHz sine wave)</p> <p>EN 61010-2-032: 2002 Safety requirements for electrical equipment for measurement control and laboratory use</p> <p>Part 2-032: Particular requirements for hand-held and hand-manipulated current sensors for electrical test and measurement With the following limits:</p> <p>300 V Installation (Overvoltage) Category I Pollution Degree 2</p>
--	---

CP031 Current Probe

GRAPHS

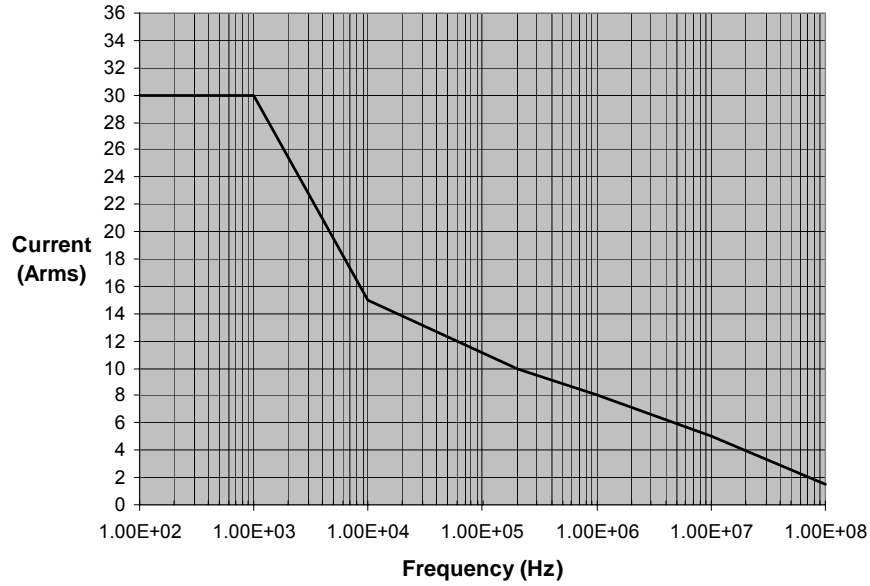

Figure 7-1. Maximum Input Current vs. Frequency

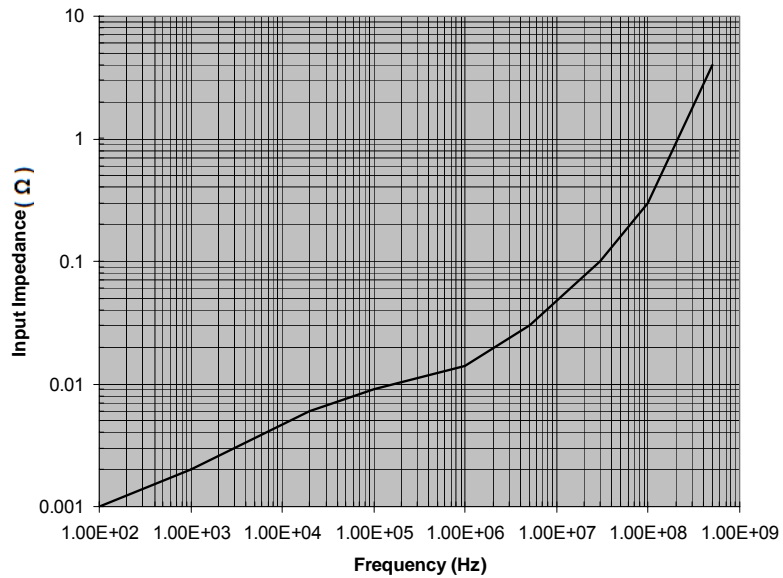

Figure 7-2. Insertion Impedance vs. Frequency

###

Appendix A

PERFORMANCE VERIFICATION TEST RECORD

This record can be used to record the results of measurements made during the performance verification of the CP031 Current Probe. Photocopy this page and record the results on the copy. File the completed record as required by applicable internal quality procedures.

The section in the test record corresponds to the parameters tested in the performance verification procedure. The numbers preceding the individual data records correspond to the steps in the procedure that require the recording of data. Results recorded in the column labeled "Test Result" are the actual specification limit check. The test limits are included in all of these steps. Other measurements and the results of intermediate calculations that support the limit check are to be recorded in the column labeled "Intermediate Results". Permission is granted to reproduce these pages for the purpose of recording test results.

Model: _____

Serial Number: _____

Asset or Tracking Number: _____

Date: _____

Technician: _____

EQUIPMENT USED:

	MODEL	SERIAL NUMBER	CALIBRATION DUE DATE
Digital Multimeter #1			
Digital Multimeter #2			
Function Generator ¹			N/A

¹The function generator used in this Performance Verification Procedure is used for making relative measurements. The output of the generator is measured with a DMM or oscilloscope in this procedure. Thus, the generator is not required to be calibrated.

CP031 Current Probe

CP031 TEST RECORD

Step	Description	Test Result
Gain Accuracy		
10	Probe Output (Spec limit: 0.495 - 0.505 V)	_____ V

###